



User Manual

ACCESSORIES CLiC-iT

INDIVIDUAL EQUIPMENTS

Swivel C-8	2
Swivel C-8+	4
Quick link	7
Climbing sling C-0 and Sewn sling C-1	8
C-HOLDER & C-TWO	10

PARK EQUIPMENTS

C-ZAM, C-ZAM L, C-ZAM L+ & C-ZAM RiDER rings	11
C-CONNECT	14
C-CONNECT V2	16
C-CONNECT V2+	18
C-CONNECT 25	20
C-CONNECT CLiC'N'ZiP	22
C-OFF	24
C-STOP Anti-return mechanical stop	25
C-UP / C-ABS	26
C-RACK	29

Utilisation

The CLiC-iT swivel is a system that allows free rotation removing the twist and may be associated with personal protective equipment.

This swivel can be mounted on personal protective equipment against falls from EN362 heights or for high rope activities. These activities are dangerous and could result in serious and even fatal injuries. It is not necessary for this product to be personally aimed at a single user in the event of a collective donation.

Carefully read and understand these instructions.

This product should only be used by trained or competent people or, where appropriate, under the direct supervision of a trained and competent person. It is your responsibility to learn about the appropriate techniques and safety measures.

In any case, this equipment must not be used beyond its limits or in any other situation for which it is not designed. If other components are used with this product, their compatibility must also be checked.

It is vital that you are positioned under the anchor point of the anti-fall system in such a way as to minimise the possibility of a fall or to minimise the height of the fall.

Leaving enough free space under the user is a basic condition for a safe stop of a fall; the height of the fall, the extension of the rope or the movement of the user's swing has to be taken into account in order to avoid all possible obstacles.

A safe and efficient rescue method should be established should someone find themselves in trouble while using this product. Ensure the user's health and medical condition, which would influence safety during normal usage and in case of an emergency when using the product.

Equipping yourself with a personal protective system against falls (PPE) does not justify freely exposing yourself to fatal risks.

The manufacturer declines all responsibility in the event of misuse or incorrect application of the product or for swivels modified or repaired by third parties not authorised by the manufacturer. These repairs must be carried out according to the operating method provided by the manufacturer.

Verify that the use of this equipment is compatible with other systems conforming to the European standards, such as for example, regarding sports equipment: EN566 sling, EN892 dynamic ropes, EN12275 connectors and the industry equipment: EN362 connectors, etc.).

As a reminder, a fall-arrest harness is the only harness designed to hold the body that will be allowed to be used in a fall-arrest system.

Verify that the system is correctly assembled and that the various elements work without interfering.

When using several articles be careful to make sure that the safety function of one of the articles is not affected by the safety function of another article or doesn't interfere with it.

The total length of a sub-system with a lanyard containing a shock absorber, manufactured ends and connectors (example: CLiC-iT PRO lanyards) cannot be longer than 2 m.

When the swivel is inserted in a fall-arrest system, pay attention to its length to properly regulate the other elements and not compromise the system's efficiency.

As a reminder, a lanyard should not be used to stop falls if it does not have a shock absorption system, for example, a shock absorber.

Storage et transport

Remove the swivel from its packaging and store it in a dry, clean and ventilated spot. The swivel should not come into contact with corrosive chemical substances, solvents and heat sources. There are no other special precautions to be taken during transport.

Maintenance

Always ensure the swivel is in good condition before and during use. Replace the swivel in case of doubts about its condition, if it shows signs of wear or corrosion. Avoid contact with heat sources, corrosive substances. In case of contact wash immediately with clean water (between 15 and 20°C) then dry with a cloth.

Verify the totality of the swivel and its proper rotation. If any doubts persist, please contact SABL DEHONDT. All maintenance and inspection of the swivel must be reported on the above inspection sheet. No lubrication is necessary under normal conditions of use.

Verify the legibility of the product's markings at each periodic inspection.

General operating instructions

Before each use, verify, inspect and ensure the compliance of the CLiC-iT swivel. In case of doubt, replace it. As a single-use (not integrated in a CLiC-iT lanyard), the system's anchor point should preferably be positioned above the user and should have a minimum resistance of 15Kn. This swivel was examined for use in standard weather conditions (-30°C/+50°C). Replace the product if it was subject to a significant fall, even if it doesn't show any faulty visual or functional aspects.

Should the swivel be used on an edge, the use of the swivel should comply with the illustrations presented in this document.

C-8+ swivel

Reference : DAS132



Material : stainless steel
Mass : 115g

Description

For use in rope parks. Swivel designed to prevent the risk of falling from a height according to the recommendations of the PPE-R / 135-V2 sheet (and relevant articles of the EN12275 standard) of the PPE 2016/425 regulation. Swivel made of stainless steel integrating a mechanical rotation without ball bearings and an openable part with double security.

Marking

Brand name : CLiC-iT - SARL DEHONDT
5 rue des Terres 51420 CERNAY-LES-REIMS
Model : 25kN Openable swivel C8+

 Pictogram indicating that users must read these instructions
EC: compliance with Regulation (UE) 2016/425 on personal protective equipment

0082: number of the intervening certifying body for the monitoring of production (module C2)

25kN : resistance guaranteed on production.

Manufacturing number: the last 4 digits represent the serial number and the first 4 digits the month and the year of manufacture.

57 mm : useful maximum length between 2 swivel rings.

Certifying body intervening for the test: UE of the type and module C2 :

APAVE SA (n°0082)

6 rue du Général Audran

92412 COURBEVOIE Cedex – France

The EU declaration of conformity is available on our website : www.clic-it.eu

Sale

For the user's safety, it is vital, if the product is resold outside the first destination country, that the distributor provides the product use, maintenance, scheduled check and repair instructions in the language of the country of use.

Life expectancy

The life expectancy of the CLiC-iT C8+ swivel depends on how and how often it is used. Including both the storage time and the time in use, the life expectancy is estimated at an average of 10 years. It should be noted that climbing or caving in a saline environment considerably reduces the life expectancy of the swivel. Avoid knocking or rubbing against sharp parts or causing fraying (eg. rocks).

Only an annual inspection by a trained and competent person or the manufacturer can determine whether or not the product is in good condition or should be taken out of use. This last point is even more true in the event of extensive use (daily use, excessive use). In any case, dispose of the swivel after 10 years of use.

Check before use

With each use, the state of the swivel must be rigorously and visually inspected by a trained and competent person. User safety is related to maintaining the efficiency and durability of the equipment.

CLiC-iT OPENABLE SWIVEL 25kN

CE 0082

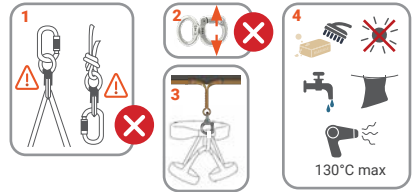
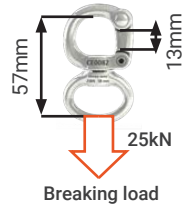

1. Prohibited assembly 2. Prohibited solicitation
3. Correct fitting on a harness 4. Storage and maintenance

IDENTIFICATION AND VERIFICATION SHEET

Model :
Type :
Serial number :
Year of manufacture :
Date of purchase :
Date of first use :
Frequency of use :

INSPECTIONS AND REPAIRS

INSPECTION 1
Date :
Defects/repairs :
Inspector's signature :

INSPECTION 2
Date :
Defects/repairs :
Inspector's signature :

INSPECTION 3
Date :
Defects/repairs :
Inspector's signature :

INSPECTION 4
Date :
Defects/repairs :
Inspector's signature :

INSPECTION 5
Date :
Defects/repairs :
Inspector's signature :

Use

The CLiC-iT C8+ swivel is a system that allows free rotation removing the twist and may be associated with personal protective equipment. This product is intended for occasional openings.

This swivel can be mounted on personal protective equipment for use on acrobatic course only. These activities are dangerous and could result in serious and even fatal injuries. It is not necessary for this product to be personally aimed at a single user in the event of a collective donation.

Carefully read and understand these instructions.

This product should only be used by trained or competent people or, where appropriate, under the direct supervision of a trained and competent person. It is your responsibility to learn about the appropriate techniques and safety measures.

In any case, this equipment must not be used beyond its limits or in any other situation for which it is not designed. If other components are used with this product, their compatibility must also be checked.

Equipping yourself with a personal protective system against falls (PPE) does not justify freely exposing yourself to fatal risks.

The manufacturer declines all responsibility in the event of misuse or incorrect application of the product or for swivels modified or repaired by third parties not authorised by the manufacturer. These repairs must be carried out according to the operating method provided by the manufacturer.

Verify that the use of this equipment is compatible with other systems conforming to the European standards, such as for example, regarding sports equipment: EN566 sling, EN892 dynamic ropes, EN12275 connectors, EN17109 lanyards.

Verify that the system is correctly assembled and that the various elements work without interfering.

When using several articles be careful to make sure that the safety function of one of the articles is not affected by the safety function of another article or doesn't interfere with it.

Storage et transport

Remove the swivel from its packaging and store it in a dry, clean and ventilated spot. The swivel should not come into contact with corrosive chemical substances, solvents and heat sources, as it would affect its resistance. There are no other special precautions to be taken during transport.

Maintenance

Always ensure the swivel is in good condition before and during use. Replace the swivel in case of doubts about its condition, if it shows signs of wear or corrosion. Avoid contact with heat sources, corrosive substances. In case of contact wash immediately with clean water (between 15 and 20°C) then dry with a cloth.

Verify the totality of the swivel and its proper rotation. If any doubts persist, please contact SARL DEHONDT. All maintenance and inspection of the swivel must be reported on the inspection sheet. No lubrication is necessary under normal conditions of use.

Verify the legibility of the product's markings at each periodic inspection.

General operating instructions

Before each use, verify, inspect and ensure the compliance of the CLiC-iT C8++ swivel. In case of doubt, replace it. This swivel was examined for use in standard weather conditions (-30°C/+50°C). Replace the product if it was subject to a significant fall, even if it doesn't show any faulty visual or functional aspects.

Effect of aging

All products are subject to aging, due to use, storage. Aging can reduce the effectiveness of the product. The aging of the product can alter the resistance of the product. The aging of the product depends directly on the use of the product, the frequency of use, the competence of the user, the environment during use. In addition, changing standards can make the product obsolete.

Component detail

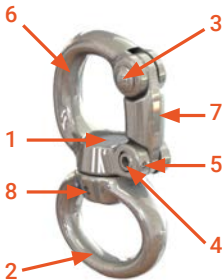

N°	Piece	Material	Quantity
1	Axis	Stain 1,4404	1
2	Ring	Stain 1,4462	1
3	Rivet	Stain 1,4301	1
4	Closing axis	Stain 1,4301	1
5	Locking screw	Stain 1,4301	1
6	Openable ring	Stain 1,4462	1
7	Finger	Stain 1,4462	1
8	Assembly pin	Stain 1,4301	1

Disassembly

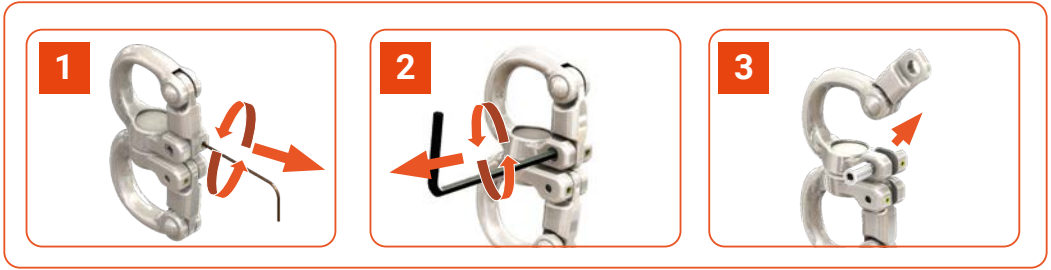

Assembly

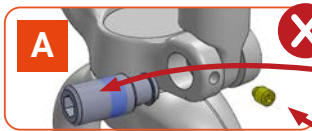
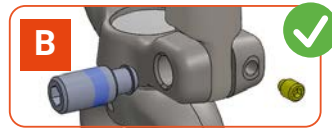

The C-8+ swivel is supplied by default with its disassembly / assembly tool. Available without tools on request.

The screws must be changed during each disassembly / assembly (thread locking glue on the locking pin (blue color))

Only screws supplied by the company CLiC-iT are authorized for mounting the swivel. Versions A and B each use a specific screw and are not interchangeable.

Only assemble in a suitable place where you can easily avoid losing the screws from the opening ring. Make sure the 2 screws are present before and after each assembly / disassembly. The two screws prevent the opening of the system. If one of the screws is missing, the C8 + swivel must not be used, in this case contact CLiC-iT technical support. Tighten the screw securely. The C8 + swivel is locked only if the latch is closed and the screws are fully tightened. Charging the C8 + in any other way is dangerous and can reduce its resistance, for example when the screws are not fully tightened. The C8 + swivel must only be opened in exceptional circumstances (For example during equipment maintenance).

Control

Before each use, check the presence and correct positioning of the safety screws.



Missing little screw



Missing large screw



Large or small screws protruding



The 2 screws must not protrude



Standard EN Maillon rapide

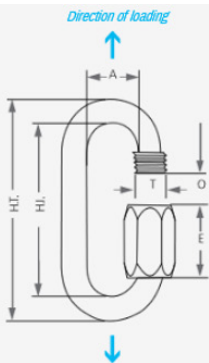

Material

APPLICATION

PPE Climbing & Mountaineering
PPE Industrial

Tightening
torque

Recommendation

Product request

Quote:
for quote request, insert quantity in the chart below
before clicking on the basket.

The original oval shape was developed on the principle of a chain link fitted with manual nut opening. This shape reflects the spirit of Maillon Rapide quick links connectors.

Stainless steel

Other materials
and dimensions

Zinc plated steel

Zircal

Reference	Diameter		Dimensions - mm						Weight	BL	Quote Qty
	mm	inches	H.T.	H.L.	A	O	E	T	g	kN	
MRNI07.0 EN	7	9/32"	66	52	16	8,5	21,5	10	52	45 kN	

Climbing sling C-0 / Sewn sling C-1



Reference : DAS060-20 C-0 20cm : DAS060-EL55 C-1 55cm
 DAS060-27 C-0 27cm : DAS060-EL70 C-1 70cm
 DAS060-35 C-0 35cm : DAS060-EL90 C-1 90cm
 DAS060-45 C-0 45cm : DAS060-EL110 C-1 110cm

DAS060-110 C-1 110cm
 DAS060-120 C-1 120cm

Life expectancy

The life expectancy of the loop depends on how and how often it is used. Including both the storage time and the time in use, the life expectancy is estimated at an average of maximum 15 years. Only an annual inspection by a trained person can determine whether or not the product is in good condition or should be taken out of use. This last point is even more true in the event of extensive use (daily use, excessive use). It may be stored for 5 years prior to use, which extends its shelf life from its date of manufacture. In any case, dispose of the loop after 10 years of use.

Sale

For the user's safety, it is vital, if the product is resold outside the first destination country, that the distributor provides the product use, maintenance, scheduled check and repair instructions in the language of the country of use.

Marking

Brand name: CLiC-iT
 Model : Sewn runner
 : Pictogram indicating that users must read these instructions
 EC: compliance with Regulation (UE) 2016/425 on personal protective equipment
 0082: number of the intervening certifying body for the monitoring of production (module C2)
 Number of European standard, i.e., EN 566: 2017
 22kN : resistance guaranteed on production
 Manufacturing number: the first 4 digits represent the serial number and the last 4 digits the year of manufacture
 Certifying body intervening for the UE test of the type and module C2 :
 APAVE SA (n°0082)
 6 rue du Général Audran
 92412 COURBEVOIE Cedex – France
The EU declaration of conformity is available on our website : www.clic-it.eu

Description

This product is a runner for mountaineering, climbing and safety.

Checks before use

Thoroughly check and inspect the condition of the runner before each use.
 Monitor possible damage such as tears, frays, cut threads and worn patches.

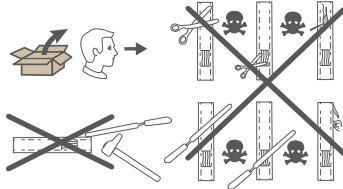

CLIMBING SLING

CE 0082
 EN 566 : 2017
 Loop



**Material : Nylon / Polyester thread
 14mm loop**

SEWN SLING

CE 0082
 EN 566 : 2017
 Loop



IDENTIFICATION AND VERIFICATION SHEET

Model :
 Type :
 Serial number :
 Year of manufacture :
 Date of purchase :
 Date of first use :
 Frequency of use :

INSPECTIONS AND REPAIRS

INSPECTION 1
 Date :
 Defects/repairs :
 Inspector's signature :

INSPECTION 2
 Date :
 Defects/repairs :
 Inspector's signature :

INSPECTION 3
 Date :
 Defects/repairs :
 Inspector's signature :

INSPECTION 4
 Date :
 Defects/repairs :
 Inspector's signature :

INSPECTION 5
 Date :
 Defects/repairs :
 Inspector's signature :

Positioning of the loop

Fit the loop onto the anchor point

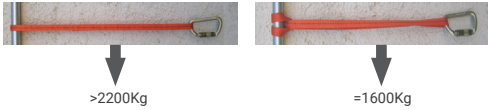

In any of the above cases, the product should not be reused without prior written authorisation by a qualified person.

Maintenance and storage

To clean, use clean warm water (max 30°C) and, if necessary, gentle soap.

Leave to dry in the open air at ambient temperature, away from all sources of direct heat. These cleaning and drying methods must be strictly adhered to.

Store the product in a dry, airy location away from direct light.

Ensure that the loops are protected against external aggressions when being transported.



Lark's head mountings

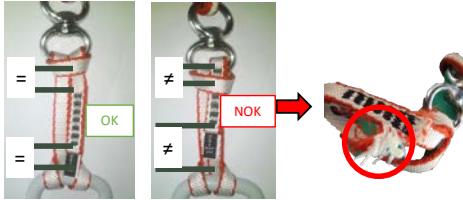

If the climbing or sewn slings are mounted on the lark's head, the lifespan is reduced to 7 years.

Use

Climbing and mountaineering activities are dangerous and may result in serious or even fatal injuries.

Please read this leaflet carefully.

This product should only be used by trained or competent people or, where appropriate, under the direct supervision of a trained and competent person. It is your responsibility to learn about the appropriate techniques and safety measures.

In any case, this equipment must not be used beyond its limits or in any other situation for which it is not designed.

In addition, if other components are used with the loop, these must be compatible. This loop must only be used with other components that comply with current European standards on mountaineering and climbing.

Precautions

Protect the loop against dangers that are likely to affect its performance by avoiding all contact with chemical reagents, electrical conductivity, jagged parts (risks due to jagged edges), abrasive surfaces or sharp edges. The rings are made of polyethylene, a material with a low melting point (140°C) and a low coefficient of friction (slippage). Avoid unnecessary exposure to UV light, extreme temperatures (exposure to frost), and to humidity.

The resistance of this product is directly affected by the knots used on it.

The loop must be withdrawn from circulation:

- If there is any doubt as to its safety
- If it has been used to stop a fall or has suffered a significant impact, even if the product does not show any signs of damage
- If the loop or the stitches are damaged
- If it shows significant signs of wear (frays, fluff)
- If it comes into contact with chemical products, acids, oil, or solvents

Periodical inspections

You should inspect your loop regularly as maintaining the efficiency and resistance of the equipment has a bearing on the user's safety:

- Before and after each use, check the condition of the product and ensure that the markings are legible.
- Check the condition of the loop and of the connections with other elements of the system during use.
- Carry out a thorough inspection of the loop at least every 12 months using the manufacturer's prescribed methods of periodical inspections. These inspections must only be carried out by the manufacturer or a manufacturer-authorized person or organisation.
- The equipment should be checked by one and the same person to ensure its better monitoring.
- The equipment may not be modified or added to without the manufacturer's prior written agreement. Do not attempt to repair the equipment yourself: if the equipment needs to be repaired, return it to the manufacturer.

C-HOLDER

Reference : DAS355



EQUIPMENT CARRIER FOR C-ZIP & CLIC'N'ZIP

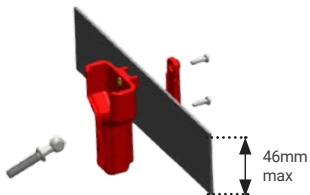

Materials : High resistant polyamide // Stainless steel

Assembly on harness

1

Place the C-HOLDER against the strap

2

Place the back bracket on the strap. Two configurations are possible, the back bracket is reversible

3

Assemble with screws provided

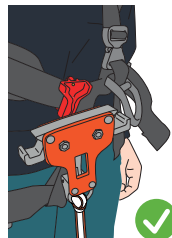

Assembly of the screw nipple on the pulley

Unscrew the central screw (TORX T30 key)

Place the screw nipple. Apply the threadlock (strong)

Screw in the nipple until the stop (8mm flat spanner)

40 kg
Breaking load

No modifications need to be made to the harness

	C-ZIP AIR // SPEED	C-ZIP LOCK // CLIC'N'ZIP	C-ZIP XTREM	CLIC-IT RIDER
Screw nipple model	<p>42mm M6 DAS354-1</p>	<p>24,5mm M6 DAS354-2</p>	<p>24,5mm M6 DAS354-2X</p>	<p>24,5mm M5 DAS354-3</p>

* Products already in circulation and requiring adaptation must be retrofitted by CLIC-IT

C-TWO

Reference : DAS046

HARNESS CONNECTOR CLIP

**Materials : Black PAHT cord Ø2 mm
100mm high-resistance polyamide handle**



Function

- > Holds the connectors on the side of the harness between routes
- > Prevents connectors from dragging on the ground, particularly when used by children

Specifications

No modifications need to be made to the harness
Tensile strength : 40 kg

Attached with a Lark's foot knot

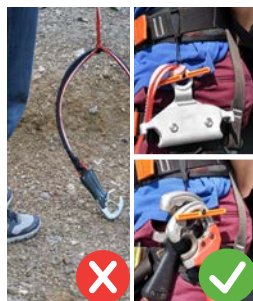

* L = adjustable length according to your needs. Contact SARL DEHONDT for any specific request

C-ZAM RING

C-ZAM ring // Reference: DAS111
 C-ZAM L ring // Reference: DAS145
 C-ZAM L+ ring // Reference: DAS148
 C-ZAM RiDER ring // Reference: DAS451



Description

C-ZAM, C-ZAM L, C-ZAM L+ and C-ZAM RiDER are designed to operate only with **CLiC-IT** safety systems. Each ring is composed of one half-ring with 1 magnet which allow CLiC-IT connectors to be detected at 180°, and one or two another half-ring(s) necessary for fitting the ring.

The **C-ZAM, C-ZAM RiDER, C-ZAM L** and **C-ZAM L+** rings are available in red (other colors are available on request) and are made from reinforced Polyamide glass fibers for optimized resistance. The **C-ZAM L / L+** rings has a central color connection area.

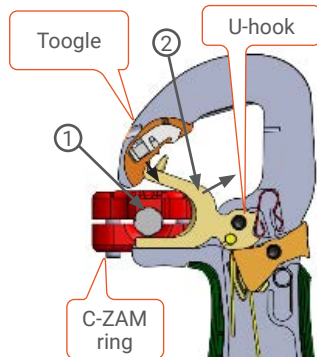

Specifications

Resistance before sliding on the cable Ø12mm : 40 kg



Compatibility

		Standards models				Specific models			
		C-ZAM	C-ZAM L	C-ZAM L+	C-ZAM RiDER	C-ZAM XL	C-ZAM DELTEX	Cable	Rope
Ø câble/rope		10≤Ø≤12,7	10≤Ø≤12,7	10≤Ø≤12,7	10≤Ø≤12	10≤Ø≤12	12,7≤Ø≤16		
Dimensions (mm)									
21 connector ● = Ø21mm	0	OK	OK	NO	OK	NO	NO	OK	OK
	1	OK	OK	NO	OK	NO	NO	OK	NO
	2	OK	OK	NO	OK	NO	NO	NO	NO
25 connector ● = Ø25mm	0	OK	OK	OK	OK	NO	NO	OK	OK
	1	OK	OK	OK	OK	NO	NO	OK	NO
	2	NO	NO	OK	OK	NO	NO	NO	NO
25 XL connector ● = Ø28mm	0	OK	OK	OK	OK	OK	OK	OK	OK
	1	OK	OK	OK	OK	OK	OK	OK	NO
	2	NO	NO	OK	OK	OK	OK	NO	NO
CLiC-IT RiDER		NO	NO	NO	OK	NO	NO	NO	NO

Operating principle

When the connector is clipped onto the ring, the magnet in the advanced **C-ZAM ring** ① triggers the connector toggle thus enabling the locking of the **U-hook** ② only onto the authorised components of the route. The C-ZAM rings enable users/operators to :

- Authorize the hooking of the connectors only* onto these rings (*CLiC-iT C-ZAM version : DAS020 Ax2*)
- Facilitate the hooking of the connector onto cables (*CLiC-iT Classic : DAS020 Ax1 version*)
- Mark out one or several routes, notably by using different colored rings
- With C-ZAM rings you can limit access to certain participants only (example : adults) on courses equipped with these rings (*C-ZAM XL model*)



For optimal operation, it is important to correctly position C-ZAM rings and connectors.

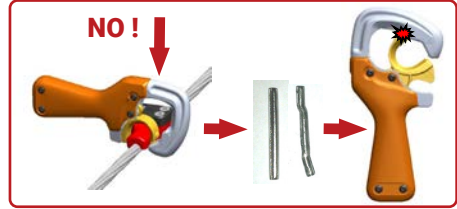

Recommendations

- Do not fit rings onto small-diameter cables
- Do not fit rings where they will undergo direct shocks or pressure (base jumps)
- Fit extra rings onto the routes to enable users to get to easy access points in case of an emergency, such as lightning or a fire. For example, allow step backwards on some courses
- Use and store C-ZAMs between -20°C and +40°C
- C-ZAM rings are fitted with powerful magnets. Do not store them close to sensitive equipment (computers, phones, watches, etc.)
- At the start of zip-lines, do not fit the pulley ahead of or on the C-ZAM ring so as to avoid damaging it.
- Provide operators with a ring to enable them to trick the system so as to evacuate users
- Have several spare rings immediately available to operators to free the lines in case of accidental damage to a C-ZAM ring. The C-ZAM rings are designed to be sturdy and long-lasting but the lack of a ring will hamper progress on a route. Therefore, this precaution is recommended
- To check effective operation and installation of the rings (ergonomic position and orientation for the user), test by hooking a CLiC-iT onto each ring before using them on the course
- When installing, lubricate all screws and bolts with Ballistol or WD40 to facilitate eventual removal. Renew the lubrication every year. Before disassembly, apply penetrating oil to the screws; let it work for a few hours before disassembling

















Forbidden manoeuvre

Do not try to trick the trigger of the connector on the top of the C-ZAM, C-ZAM L, C-ZAM L+ or C-ZAM RiDER ring

Fitting tools required

- **C-ZAM** : 5 mm BTR key, can be installed with a screw gun
- **C-ZAM L and C-ZAM L+** : TORX T30 key, can be installed with a screw gun
- **C-ZAM RiDER** : 1.3mm BTR key and 1.5mm BTR key, can be installed with a screw gun

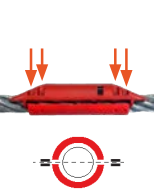
Procedure for fitting

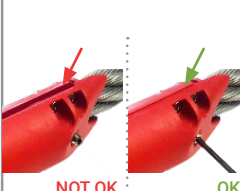
	Material provided	STEP 2	STEP 3	STEP 4	STEP 5
	- C-ZAM rings - Screws	POSITION BOTH HALF-RINGS ON YOUR CABLE OR YOUR ROPE	SCREW CROSSWISE WITHOUT TIGHTENING ALL THE WAY	FINISH SCREWING THE SCREWS CROSSWISE Tightening with screw gun possible (be careful to limit the torque)	INSERT THE 2 M3X6 SCREWS & TIGHEN UNTIL BLOCKING
C-ZAM	 x4		 BTR 5mm		
C-ZAM L / L+	 x4		 TORX T30		
C-ZAM XL	 x4		 TORX T30		
C-ZAM RiDER	 x8 M2x8 x2 M3x6 Required tools: DAS451CLE (M2x8) DAS226 (M3x6)	 Preposition M2 screws	 BTR 1.3mm		 NOT OK OK

Installation instructions on 10 diameter and C-OFF elements

Wrap Chatterton scotch tape around the 10 diameter cable 3 times in order to obtain a diameter of 12

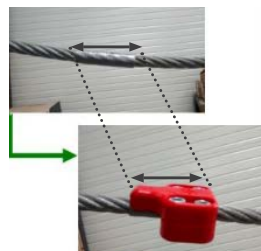
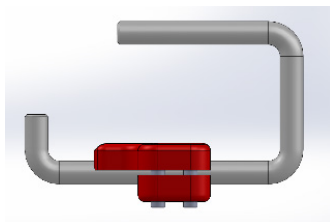

Material : C45 steel
Mass : 158g

Life expectancy

The life expectancy of the products depends on how and how often it is used. Including both the storage time and the time in use, the life expectancy is estimated at an average of 10 years. It should be noted that use in a saline environment considerably reduces the life expectancy of the swivel. Avoid knocking or rubbing against sharp parts or causing fraying (eg. rocks).

Only an annual inspection by a trained and competent person can determine whether or not the product is in good condition or should be taken out of use. This last point is even more true in the event of extensive use (daily use, excessive use). In any case, dispose of the swivel after 10 years of use.

Sale

For the user's safety, it is vital, if the product is resold outside the first destination country, that the distributor provides the product use, maintenance, scheduled check and repair instructions in the language of the country of use.

Marking

Brand name : CLiC-iT

Model : C-CONNECT

: Pictogram indicating that users must read these instructions
EC: compliance with Regulation (UE) 2016/425 on personal protective equipment

0082: number of the intervening certifying body for the monitoring of production (module C2)

25kN : resistance guaranteed on production

Manufacturing number: the last 4 digits represent the serial number and the first 4 digits the month and the year of manufacture

78 mm: maximum operating length between the C-CONNECT fixing area and the CLiC-iT grip zone

Certifying body intervening for the UE test of the type and module C2:

APAVE SA (n°0082)

6 rue du Général Audran

92412 COURBEVOIE Cedex – France

The EU declaration of conformity is available on our website : www.clic-it.eu

Description

C-CONNECT made out of C45 steel integrating a buried magnet in a red high-resistance resin.

Checks before use

With each use, the state of the product must be rigorously and visually inspected by a trained and competent person.

Fixing zone on sling or rope

C-CONNECT body

Magnet

Resin & colorant

Connection zone to connect 2 CLiC-iT connectors

Connector	C-CONNECT	
	0	OK
	1	OK
	2	OK
	0	OK
	1	NO
	2	NO

78 mm

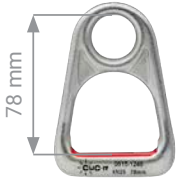

IDENTIFICATION AND VERIFICATION SHEET

Model :

Type :

Serial number :

Year of manufacture :

Date of purchase :

Date of first use :

Frequency of use :

INSPECTIONS AND REPAIRS

INSPECTION 1

Date :

Defects/repairs :

Inspector's signature :

INSPECTION 2

Date :

Defects/repairs :

Inspector's signature :

INSPECTION 3

Date :

Defects/repairs :

Inspector's signature :

INSPECTION 4

Date :

Defects/repairs :

Inspector's signature :

INSPECTION 5

Date :

Defects/repairs :

Inspector's signature :

Use

The CLiC-iT C-CONNECT is a connecting element to be used with individual protection equipment for high wire climbing. It is not necessary for this product to be personally aimed at a single user in the event of a collective donation.

Carefully read and understand these instructions.

This product should only be used by trained or competent people or, where appropriate, under the direct supervision of a trained and competent person. It is your responsibility to learn about the appropriate techniques and safety measures. In any case, this equipment must not be used beyond its limits or in any other situation for which it is not designed.

If other components are used with this product, their compatibility must also be checked.

Equipping yourself with a personal protective system against falls (PPE) does not justify freely exposing yourself to fatal risks. The manufacturer declines all responsibility in the event of misuse or incorrect application of the product or for products modified or repaired by third parties not authorised by the manufacturer. These repairs must be carried out according to the operating method provided by the manufacturer.

Verify that the use of this equipment is compatible with other systems conforming to the European standards.

Verify that the system is correctly assembled and that the various elements work without interfering. **Caution** : When using several articles be careful to make sure that the safety function of one of the articles is not affected by the safety function of another article or doesn't interfere with it.

Additional important recommendation to follow

It is vital that you are positioned under the anchor point of the anti-fall system in such a way as to minimise the possibility of a fall or to minimise the height of the fall.

Leaving enough free space under the user is a basic condition for a safe stop of a fall; the height of the fall, the extension of the rope or the movement of the user's swing has to be taken into account in order to avoid all possible obstacles.

A safe and efficient rescue method should be established should someone find themselves in trouble while using this product. Ensure the user's health and medical condition, which would influence safety during normal usage and in case of an emergency when using the product.

Storage et transport

Remove the product from its packaging and store it in a dry, clean and ventilated spot. The product should not come into contact with corrosive chemical substances, solvents and heat sources. There are no other special precautions to be taken during transport.

Maintenance

Always ensure the product is in good condition before and during use. Replace the product in case of doubts about its condition, if it shows signs of wear or corrosion. Avoid contact with heat sources, corrosive substances. In case of contact wash immediately with clean water (between 15 and 20°C) then dry with a cloth. Verify the totality of the product and its proper rotation. If any doubts persist, please contact SARL DEHONDT. All maintenance and inspection of the product must be reported on the above inspection sheet. No lubrication is necessary under normal conditions of use. Verify the legibility of the product's markings at each periodic inspection.

General operating instructions

Before each use, verify, inspect and ensure the compliance of the product. In case of doubt, replace it. This product was examined for use in standard weather conditions (-30°C/+50°C). Replace the product if it was subject to a significant fall, even if it doesn't show any faulty visual or functional aspects. Check the wear of the attachment loop on sling and rope

If the connector is blocked

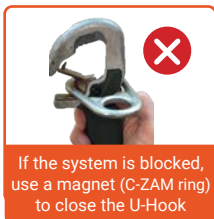

Fixing CLiC-iT connectors to C-CONNECT

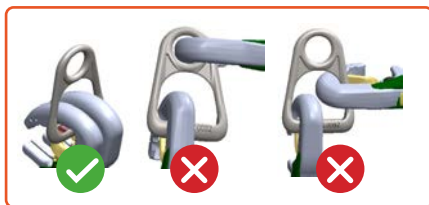

Fixing C-CONNECT to sling or rope (outside PPE directive)



Use as PPE

The C-CONNECT may be placed between the connecting element of an automatic return anti-fall device (quick open link or detachable connector), and the CLiC-iT connectors.



C-CONNECT V2

Reference : DAS170



Material : 6082 T6 steel
Mass : 135g

Life expectancy

The life expectancy of the products depends on how and how often it is used. Including both the storage time and the time in use, the life expectancy is estimated at an average of 10 years. It should be noted that use in a saline environment considerably reduces the life expectancy of the swivel. Avoid knocking or rubbing against sharp parts or causing fraying (eg. rocks).

Only an annual inspection by a trained and competent person can determine whether or not the product is in good condition or should be taken out of use. This last point is even more true in the event of extensive use (daily use, excessive use). In any case, dispose of the swivel after 10 years of use.

Sale

For the user's safety, it is vital, if the product is resold outside the first destination country, that the distributor provides the product use, maintenance, scheduled check and repair instructions in the language of the country of use.

Marking

Brand name : CLiC-iT

Model : C-CONNECT V2

 Pictogram indicating that users must read these instructions
EC: compliance with Regulation (UE) 2016/425 on personal protective equipment

0082: number of the intervening certifying body for the monitoring of production

20kN : resistance guaranteed on production.

Manufacturing number: the last 4 digits represent the serial number and the first 4 digits the month and the year of manufacture.

100 mm: maximum operating length between the C-Connect fixing area and the CLiC-iT grip zone.

Certifying body intervening for the UE test of the type and module C2:

APAVE SA (n°0082)

6 rue du Général Audran

92412 COURBEVOIE Cedex – France

The EU declaration of conformity is available on our website : www.clic-it.eu

Description

C-CONNECT V2 made out of 6082 T6 steel integrating a buried magnet in a red high-resistance resin.

Checks before use

With each use, the state of the product must be rigorously and visually inspected by a trained and competent person.



Connector		C-CONNECT V2
	0	OK
	1	OK
	2	OK
	0	OK
	1	OK
	2	OK



IDENTIFICATION AND VERIFICATION SHEET

Model :
Type :
Serial number :
Year of manufacture :
Date of purchase :
Date of first use :
Frequency of use :

INSPECTIONS AND REPAIRS

INSPECTION 1

Date :
Defects/repairs :

Inspector's signature :

INSPECTION 2

Date :
Defects/repairs :

Inspector's signature :

INSPECTION 3

Date :
Defects/repairs :

Inspector's signature :

INSPECTION 4

Date :
Defects/repairs :

Inspector's signature :

INSPECTION 5

Date :
Defects/repairs :

Inspector's signature :

Use

The CLiC-iT C-CONNECT V2 is a connecting element to be used with individual protection equipment for high wire climbing. The C-CONNECT V2 is intended for use in high ropes courses only. It is not necessary for this product to be personally aimed at a single user in the event of a collective donation. **Carefully read and understand these instructions.** This product should only be used by trained or competent people or, where appropriate, under the direct supervision of a trained and competent person. It is your responsibility to learn about the appropriate techniques and safety measures. In any case, this equipment must not be used beyond its limits or in any other situation for which it is not designed. If other components are used with this product, their compatibility must also be checked.

Equipping yourself with a personal protective system against falls (PPE) does not justify freely exposing yourself to fatal risks.

The manufacturer declines all responsibility in the event of misuse or incorrect application of the product or for products modified or repaired by third parties not authorised by the manufacturer. These repairs must be carried out according to the operating method provided by the manufacturer.

Verify that the use of this equipment is compatible with other systems conforming to the European standards.

Verify that the system is correctly assembled and that the various elements work without interfering.

Warning : when using several articles be careful to make sure that the safety function of one of the articles is not affected by the safety function of another article or doesn't interfere with it.

Additional important recommendation to follow

It is vital that you are positioned under the anchor point of the anti-fall system in such a way as to minimise the possibility of a fall or to minimise the height of the fall.

Leaving enough free space under the user is a basic condition for a safe stop of a fall; the height of the fall, the extension of the rope or the movement of the user's swing has to be taken into account in order to avoid all possible obstacles.

A safe and efficient rescue method should be established should someone find themselves in trouble while using this product. Ensure the user's health and medical condition, which would influence safety during normal usage and in case of an emergency when using the product.

Storage and transport

Remove the product from its packaging and store it in a dry, clean and ventilated spot. The product should not come into contact with corrosive chemical substances, solvents and heat sources, as these may reduce the product's characteristics. Improper storage of the product may lead to a deterioration in its resistance. There are no other special precautions to be taken during transport.

Entretien

Always ensure the product is in good condition before and during use. Replace the product in case of doubts about its condition, if it shows signs of wear or corrosion. Avoid contact with heat sources, corrosive substances. In case of contact wash immediately with clean water (between 15 and 20°C) then dry with a cloth. Verify the totality of the product and its proper rotation. If any doubts persist, please contact SARL DEHONDT. All maintenance and inspection of the product must be reported on the above inspection sheet. Verify the legibility of the product's markings at each periodic inspection

General operating instructions

Before each use, verify, inspect and ensure the compliance of the product. In case of doubt, replace it. This product was examined for use in standard weather conditions (-30°C/+50°C). Replace the product if it was subject to a significant fall, even if it doesn't show any faulty visual or functional aspects. Check the wear of sling or rope loop.

Fixing CLiC-iT connectors

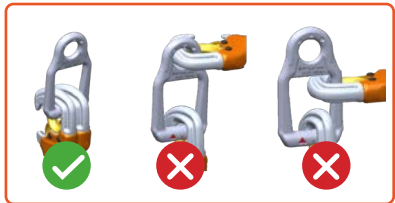

Fixing C-CONNECT V2 to sling or rope (outside PPE directive)

Use as PPE



Do not connect the C-CONNECT V2 directly to a zip wire



The C-CONNECT V2 may be placed between the connecting element of an automatic return anti-fall device (quick open link or detachable connector), and the CLiC-iT MCD.

Automatic return anti-fall device

Quick open link, to be put in place by the user

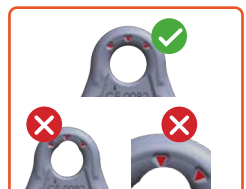

If wear reaches one of the indicators, discard the product

Material : 6082 T6 steel
Mass : 140g

Life expectancy

The life expectancy of the products depends on how and how often it is used. Including both the storage time and the time in use, the life expectancy is estimated at an average of 10 years. It should be noted that use in a saline environment considerably reduces the life expectancy of the swivel. Avoid knocking or rubbing against sharp parts or causing fraying (eg. rocks).

Only an annual inspection by a trained and competent person can determine whether or not the product is in good condition or should be taken out of use. This last point is even more true in the event of extensive use (daily use, excessive use). In any case, dispose of the swivel after 10 years of use.

Sale

For the user's safety, it is vital, if the product is resold outside the first destination country, that the distributor provides the product use, maintenance, scheduled check and repair instructions in the language of the country of use.

Marking

Brand name : CLiC-iT

Model : C-CONNECT V2+

 Pictogram indicating that users must read these instructions
EC: compliance with Regulation (UE) 2016/425 on personal protective equipment

0082: number of the intervening certifying body for the monitoring of production

20kN : resistance guaranteed on production.

Manufacturing number: the last 4 digits represent the serial number and the first 4 digits the month and the year of manufacture.

100 mm: maximum operating length between the C-Connect fixing area and the CLiC-iT grip zone.

Certifying body intervening for the UE test of the type and module C2:

APAVE SA (n°0082)

6 rue du Général Audran

92412 COURBEVOIE Cedex – France

The EU declaration of conformity is available on our website : www.clic-it.eu



Description

C-CONNECT V2+ made out of 6082 T6 steel integrating a buried magnet in a red high-resistance resin.

Checks before use

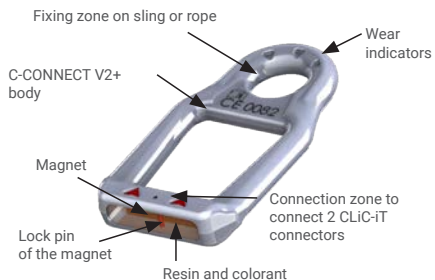
With each use, the state of the product must be rigorously and visually inspected by a trained and competent person.



Connector		C-CONNECT V2+
	0	NO
	1	
	2	
	0	OK
	1	OK
	2	OK



IDENTIFICATION AND VERIFICATION SHEET

Model :
Type :
Serial number :
Year of manufacture :
Date of purchase :
Date of first use :
Frequency of use :

INSPECTIONS AND REPAIRS

INSPECTION 1

Date :
Defects/repairs :

Inspector's signature :

INSPECTION 2

Date :
Defects/repairs :

Inspector's signature :

INSPECTION 3

Date :
Defects/repairs :

Inspector's signature :

INSPECTION 4

Date :
Defects/repairs :

Inspector's signature :

INSPECTION 5

Date :
Defects/repairs :

Inspector's signature :

Use

The CLiC-iT C-CONNECT V2+ is a connecting element to be used with individual protection equipment for high wire climbing. The C-CONNECT V2+ is intended for use in high ropes courses only. It is not necessary for this product to be personally aimed at a single user in the event of a collective donation. **Carefully read and understand these instructions.** This product should only be used by trained or competent people or, where appropriate, under the direct supervision of a trained and competent person. It is your responsibility to learn about the appropriate techniques and safety measures. In any case, this equipment must not be used beyond its limits or in any other situation for which it is not designed. If other components are used with this product, their compatibility must also be checked.

Equipping yourself with a personal protective system against falls (PPE) does not justify freely exposing yourself to fatal risks.

The manufacturer declines all responsibility in the event of misuse or incorrect application of the product or for products modified or repaired by third parties not authorised by the manufacturer. These repairs must be carried out according to the operating method provided by the manufacturer.

Verify that the use of this equipment is compatible with other systems conforming to the European standards.

Verify that the system is correctly assembled and that the various elements work without interfering.

Warning: When using several articles be careful to make sure that the safety function of one of the articles is not affected by the safety function of another article or doesn't interfere with it.

Additional important recommendation to follow

It is vital that you are positioned under the anchor point of the anti-fall system in such a way as to minimise the possibility of a fall or to minimise the height of the fall.

Leaving enough free space under the user is a basic condition for a safe stop of a fall; the height of the fall, the extension of the rope or the movement of the user's swing has to be taken into account in order to avoid all possible obstacles.

A safe and efficient rescue method should be established should someone find themselves in trouble while using this product. Ensure the user's health and medical condition, which would influence safety during normal usage and in case of an emergency when using the product.

Storage and transport

Remove the product from its packaging and store it in a dry, clean and ventilated spot. The product should not come into contact with corrosive chemical substances, solvents and heat sources, as these may reduce the product's characteristics. Improper storage of the product may lead to a deterioration in its resistance. There are no other special precautions to be taken during transport.

Maintenance

Always ensure the product is in good condition before and during use. Replace the product in case of doubts about its condition, if it shows signs of wear or corrosion. Avoid contact with heat sources, corrosive substances. In case of contact wash immediately with clean water (between 15 and 20°C) then dry with a cloth. Verify the totality of the product and its proper rotation. If any doubts persist, please contact SARL DEHONDT. All maintenance and inspection of the product must be reported on the above inspection sheet. Verify the legibility of the product's markings at each periodic inspection

General operating instructions

Before each use, verify, inspect and ensure the compliance of the product. In case of doubt, replace it. This product was examined for use in standard weather conditions (-30°C/+50°C). Replace the product if it was subject to a significant fall, even if it doesn't show any faulty visual or functional aspects. Check the wear of sling or rope loop.

Fixing CLiC-iT connectors

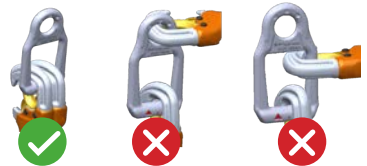

Fixing C-CONNECT V2+ to sling or rope (outside PPE directive)



Do not connect the C-CONNECT V2+ directly to a zip wire



Use as PPE

The C-CONNECT V2+ may be placed between the connecting element of an automatic return anti-fall device (quick open link or detachable connector), and the CLiC-iT MCD.

Automatic return anti-fall device

Quick open link, to be put in place by the user



If wear reaches one of the indicators, discard the product

C-CONNECT 25

Reference : DAS346



Material : Steel // Mass : 402g

Life expectancy

The life expectancy of the products depends on how and how often it is used. Including both the storage time and the time in use, the life expectancy is estimated at an average of 10 years. It should be noted that use in a saline environment considerably reduces the life expectancy of the swivel. Avoid knocking or rubbing against sharp parts or causing fraying (eg. rocks).

Only an annual inspection by a trained and competent person can determine whether or not the product is in good condition or should be taken out of use. This last point is even more true in the event of extensive use (daily use, excessive use). In any case, dispose of the swivel after 10 years of use.

Sale

For the user's safety, it is vital, if the product is resold outside the first destination country, that the distributor provides the product use, maintenance, scheduled check and repair instructions in the language of the country of use.

Marking

CLiC-IT : Brand name

: Pictogram indicating that users must read these instructions

CE : compliance with Regulation (UE) 2016/425 on personal protective equipment

0082 : number of the intervening certifying body for the monitoring of production

↓ 25kN : Direction of use and resistance guaranteed on production

Manufacturing number : The first 4 digits represent the year and the month of manufacture

Certifying body intervening for the UE test of the type and module C2:

APAVE SA (n°0082)

6 rue du Général Audran

92412 COURBEVOIE Cedex – France

The EU declaration of conformity is available on our website : www.clic-it.eu

Description

The C-CONNECT 25 is a connecting element made of steel, providing an optimum connection of CLiC-IT ADVENTURE lanyards onto anchorage points of fall arrest systems (devices) and onto rope with knots.

Check before use

With each use, the state of the product must be rigorously and visually inspected by a trained and competent person.

Use

The CLiC-IT C-CONNECT 25 is a connecting element to be used with individual protection equipment for high wire climbing. It is not necessary for this product to be personally aimed at a single user in the event of a collective donation.

Carefully read and understand these instructions.

This product should only be used by trained or competent people or, where appropriate, under the direct supervision of a trained and competent person. It is your responsibility to learn about the appropriate techniques and safety measures.

In any case, this equipment must not be used beyond its limits or in any other situation for which it is not designed. If other components are used with this product, their compatibility must also be checked.

Equipping yourself with a personal protective system against falls (PPE) does not justify freely exposing yourself to fatal risks. The manufacturer declines all responsibility in the event of misuse or incorrect application of the product or for products modified or repaired by third parties not authorised by the manufacturer. These repairs must be carried out according to the operating method provided by the manufacturer. Verify that the use of this equipment is compatible with other systems conforming to the European standards. Verify that the system is correctly assembled and that the various elements work without interfering. **Caution** : When using several articles be careful to make sure that the safety function of one of the articles is not affected by the safety function of another article or doesn't interfere with it.

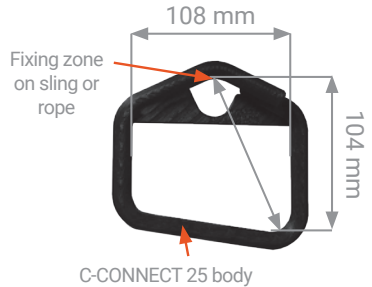

Anchor detection	C-CONNECT 25
0	OK
1	OK
2	OK

IDENTIFICATION AND VERIFICATION SHEET

Model :
Type :
Serial number :
Year of manufacture :
Date of purchase :
Date of first use :
Frequency of use :

INSPECTIONS AND REPAIRS

INSPECTION 1

Date :
Defects/repairs :

Inspector's signature :

INSPECTION 2

Date :
Defects/repairs :

Inspector's signature :

INSPECTION 3

Date :
Defects/repairs :

Inspector's signature :

INSPECTION 4

Date :
Defects/repairs :

Inspector's signature :

INSPECTION 5

Date :
Defects/repairs :

Inspector's signature :

Additional important recommendation to follow

It is vital that you are positioned under the anchor point of the anti-fall system in such a way as to minimise the possibility of a fall or to minimise the height of the fall. Il est impératif de prendre en compte la longueur de l'équipement lors de l'installation sur un atelier, pour minimiser la hauteur de la chute. Leaving enough free space under the user is a basic condition for a safe stop of a fall; the height of the fall, the extension of the rope or the movement of the user's swing has to be taken into account in order to avoid all possible obstacles.

A safe and efficient rescue method should be established should someone find themselves in trouble while using this product. Ensure the user's health and medical condition, which would influence safety during normal usage and in case of an emergency when using the product. Beware of the risk of injury or head shock when unhooking the C-CONNECT from the connectors.

Storage and transport

Remove the product from its packaging and store it in a dry, clean and ventilated spot. The product should not come into contact with corrosive chemical substances, solvents and heat sources. There are no other special precautions to be taken during transport.

Maintenance

Always ensure the product is in good condition before and during use. Replace the product in case of doubts about its condition, if it shows signs of wear or corrosion. Avoid contact with heat sources, corrosive substances. In case of contact wash immediately with clean water (between 15 and 20°C) then dry with a cloth. Verify the totality of the product. If any doubts persist, please contact SARL DEHONDT.

All maintenance and inspection of the product must be reported on the above inspection sheet. Verify the legibility of the product's markings at each periodic inspection.

General operating instructions

Before each use, verify, inspect and ensure the compliance of the product. In case of doubt, replace it. This product was examined for use in standard weather conditions (-30°C/+50°C). Replace the product if it was subject to a significant fall, even if it doesn't show any faulty visual or functional aspects. Check the wear of sling or rope loop.

With C-ZAM L+ ring option

C-ZAM L+
(DAS149)



Fixing C-CONNECT 25 to sling / rope



Do not connect the C-CONNECT directly to an unremovable cable

Scraping



Anchor point wear

Deformation of the plate

Deformation of the structure

Use as PPE

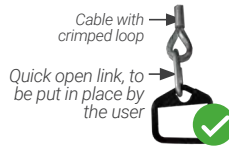

The C-CONNECT 25 may be placed between the connecting element (quick open link or detachable connector), and the CLiC-iT connectors.

CAUTION : The quick link must be tightened to the correct torque

further informations

The C-CONNECT 25 can be used in PAH for vertical progressions.

Operating temperature : The use and storage temperature range should be between - 10 and +50°C. Outside this temperature range, the product resistance could be affected.

Avoid any rubbing on abrasive or sharp areas which may damage the product. Avoid contact with chemical products, notably acids which can reduce the resistance of the product without any visible effect.

Maintenance - Modification - Repair

This product must be thoroughly checked annually by a qualified professional with a prior written certification from SARL DEHONDT. It is forbidden to modify or repair this product yourself without prior training and written authorisation from SARL DEHONDT.

Life expectancy : The life expectancy corresponds to the storage time before use + time in use. **Storage time :** in proper storage conditions, this product may be stored for 5 years before first use without affecting its lifetime in use. Storage and aging due to use of the product may reduce its strength.

Lifetime in use : 10 years maximum. Safety checks determine if the product should be scrapped or repaired.

Performance during technical inspections : Static resistance of the product: > 25 kN // **Protection Class :** 3. Risk of fatal fall.

C-CONNECT CLiC'N'ZiP

Reference : DAS184



Material : Ø10 steel wire with anti-corrosion coating
Mass : 540g

Life expectancy

The life expectancy of the product is 10 years, including the storage period. This life expectancy may be reduced depending on the frequency and environment of use, especially in a saline environment. Avoid knocking or rubbing against sharp parts or causing fraying (eg. rocks)

Sale

In case of resale, this user manual must be translated into the language of the country of use.

Marking

CLiC-iT : Brand name

: Pictogram that indicates users must read these instructions

CE : Compliance with Regulation (UE) 2016/425 on personal protective equipment

0082 : Number of the certifying body in charge of the production follow up

15kN : Guaranteed resistance at the time of production

Manufacturing number : Reference - Year - Week

100 mm : Maximum useful length between attachment point and connection point

Description

Specific anchor point for CLiC'N'ZiP lanyards with integrated pulley. For installation on work-sop requiring an anchor point outside the lifeline (Tarzan jumps, rolling games such as surfing, ...) or automatic fall arrest systems.

Installation

Link

Use the upper fixing zone to attach the C-CONNECT. Attachment in direct contact on a rope (in accordance with EN1891 type A Ø10mm) is permitted. Attachment in direct contact on a cable loop with cable thimble is forbidden, in this case, a quick link (MRN107.0) must be placed between the loop and the C-CONNECT.



Height

Leaving enough free space under the user is a basic requirement for a safe stop of a fall, the length of the fall, the elongation of the rope the pendulum movement of the user must be taken into account in order to avoid all possible obstacles.

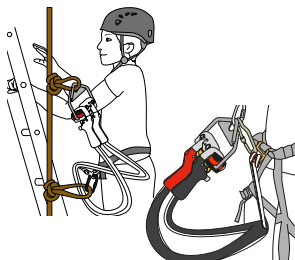

For jumps in the air (QuickJump, Tarzan jump...), use a third anchor point to be connected directly to the harness trigger guard in addition to the C-CONNECT CLiC'N'ZiP. This ensures redundant safety and prevents the lanyards from being tensioned during a jump, thus protecting the lanyards and control cables from premature wear. Make sure and check that the fall arrester automatically ascends.

To avoid the risk of injury, make sure that the C-CONNECT CLiC'N'ZiP and the connectors are positioned out of reach of the face.

Sling or rope attachment point

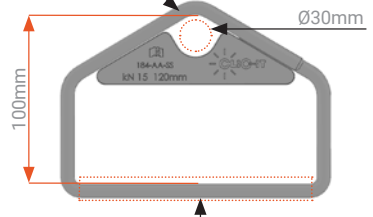

Connection point of the connectors

CLiC'N'ZiP COMPATIBILITY



IDENTIFICATION AND VERIFICATION SHEET

Model :

Type :

Serial number :

Year of manufacture :

Date of purchase :

Date of first use :

Frequency of use :

INSPECTIONS AND REPAIRS

INSPECTION 1

Date :

Defects/repairs :

Inspector's signature :

INSPECTION 2

Date :

Defects/repairs :

Inspector's signature :

INSPECTION 3

Date :

Defects/repairs :

Inspector's signature :

INSPECTION 4

Date :

Defects/repairs :

Inspector's signature :

INSPECTION 5

Date :

Defects/repairs :

Inspector's signature :

C-ZAM L+ ring installation



Use

Always connect the two connectors of the lanyard on the C-CONNECT before starting the course. The connector with pulley is placed on the steel bar. The 25 connector is placed on the C-ZAM L+ ring.

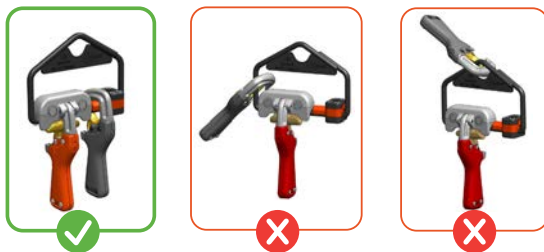

Maintenance

Check the condition of the C-CONNECT regularly. If you notice any deformation, wear or corrosion, replace it immediately. If the C-CONNECT has been subject to a major fall, replace the product even if it has no visual or functional defects. Do not expose C-CONNECT to corrosive substances. In the event of contact, rinse with clean water, dry the object and inspect its condition before putting it into service.

Precautions for use

The C-CONNECT CLIC'N'ZIP is a connection element that must be associated with personal protective equipment for climbing. It is not necessary for this product to be used personally by a single user in case of collective equipment.

Read carefully and understand these instructions. This product should only be used by trained or competent persons or, if applicable, under the direct supervision of trained and competent person. You are solely responsible for learning the proper techniques and safety precautions. In any case, this equipment must not be used beyond its limits or in any situation other than that for which it is intended. In addition, if other components are used with this product, it is imperative to check their compatibility.

The use of a personal fall protection device (P.P.E) does not justify deliberately exposing oneself to fatal risks.

The manufacturer declines all responsibility for incorrect use or incorrect application of the products or for products modified by persons not authorized by the manufacturer. Any structural modification is forbidden.

Check that the use of this equipment is compatible with other systems that comply with European standards.

Make sure that the product is assembled correctly and that the various elements work without interfering.

Caution : when using several items make sure the safety function of one item is not affected by or interferes with the safety function of another item.

Material : Ø10mm zinc-plated steel

Descriptif

- > Permits the removal of the 2 connectors on the lifeline at the start and end of a route : to be fitted only at ground level
- > Fitted with cable clamps (not supplied)
- > Compatible with C-ZAM ring

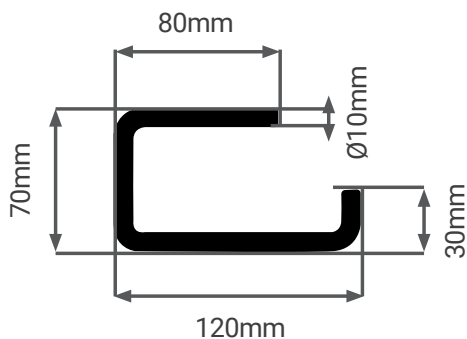

ANTI-RETURN MECHANICAL STOP

Material : Treated steel with a resistance to 100H of salt spray

Dimension :
Ø 20mm x 60mm

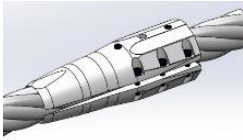

CLiC-iT connector
sliding pin area

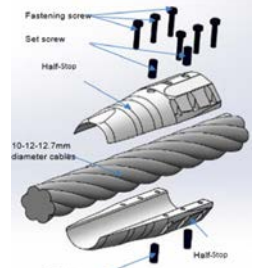
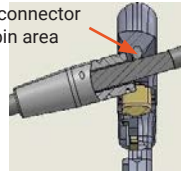

Installation

- Possible installation on metallic and plastic sheathed 10, 12 and 12,7 mm diameter cables
- To be installed on a sloping course with angles of 18° to 35°
- 2 meters is the maximum distance between two stops recommended by SARL DEHONDT

1. Use the CLiC-iT tightening tool



2. Assemble the 4 set screws



4. Assemble the 6 fastening screws

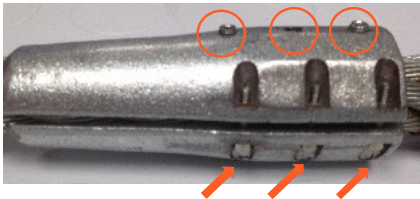

3. Cable preparation

In order to protect cable, wrap it twice with American sellotape before fitting the mechanical stop (4 turns for a 10 mm diameter cable).



5. Tighten the 4 set screws



6. Check the holding of the C-STOP on the cable

Maintenance and recommendation

After a fall, and the resulting stop of CLiC-iT connectors caused by the anti-return mechanical stop, it is important to check the condition of the mechanical stop (condition of the set screws and the Half-stop) and also the condition of the CLiC-iT connectors (sliding pin zone). As the anti-return mechanical stop is a one-use stopper, it is not designed to withstand repeated shocks. Not respecting this recommendation can cause damage to the anti-return stop and, as a result, reduced function in the case of a fall. Perform a monthly check to ensure that the screws are properly tightened on the cables and the good condition of the safety line cable. Non-compliance with these recommendations could lead to suppression of its stop function in the event of a fall.

Function

The anti-return mechanical stop allows the use of CLiC-iT Adventure-Mountain and Pro connector models on sloping courses, while acting as a safety stop during the fall of a person with a maximum mass of 80kg.

Informations générales / General information

1. Présentation des produits / Product overview :

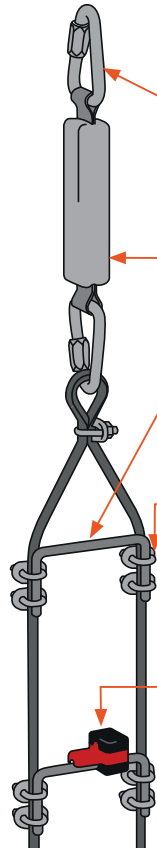

H eight of the platform

H hauteur de la plateforme

DESIGNATION	REF	2m	3m	4m	5m	6m
Maillon DELTA 12 Acier zingué EN362 DELTA 12 Link Galvanized steel EN362	DAS371	2	2	2	2	2
C-ABS Absorbant d'énergie Shock absorber Norme EN355-2002 / EN355-2002 standard	DAS192	2*	2*	2*	2*	2*
C-UP Barreau acier Ø10 revêtu Steel stiles Ø10	DAS193	6	9	11	14	16
Serre-câble Ø10 Acier forgé Ø10 cable clamp Forged steel <i>Recommandé / Recommended</i>	DAS593-10	24	36	44	56	64
Serre-câble Ø12 Acier forgé Ø12 cable clamp Forged steel	DAS593-12	24	36	44	56	64
C-ZAM Bague / Ring	DAS111 R	6	9	11	14	16
C-ZAM L+ Bague / Ring	DAS148 R	6	9	11	14	16

2. Compatibilité / Compatibility :

NU / Bare

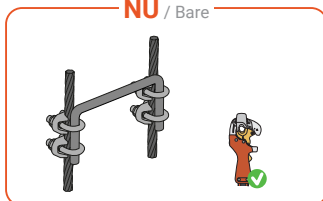

AVEC / With **C-ZAM**

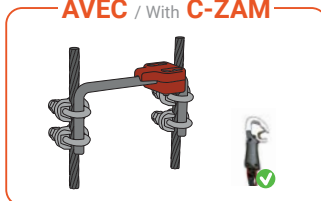

AVEC / With **C-ZAM L+**

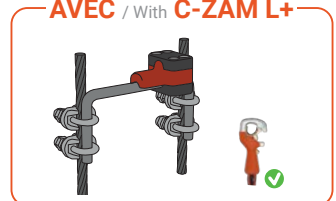

* *Recommandation : 2 C-ABS afin de disposer d'un exemplaire de remplacement en cas de déclenchement du premier*

3. Installation : (Dans le respect de la norme de construction des parcs EN15-567-1)

Installation : (In accordance of the EN15-567-1 - park building standard)

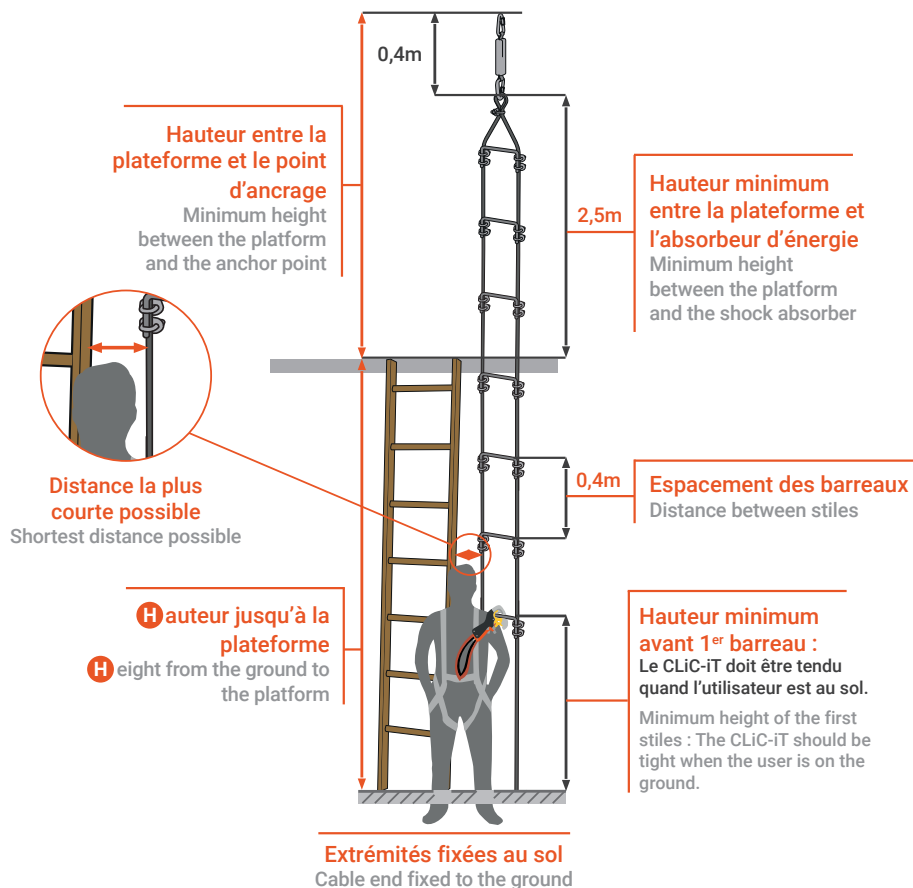

> Ne pas lier le système C-UP à l'échelle, ou à tout autre élément statique. Cela neutraliserait l'effet de l'absorbeur de chute. Do not tie the C-UP system to the ladder, or any other static element. This would nullify the effect of the shock absorber.

> Le système C-UP peut être construit avec du câble acier Ø10 minimum (recommandé) à Ø12 maximum. Câbles non fournis par CLiC-iT. The C-UP system can be built with steel cable Ø10 minimum (recommended) to Ø12 maximum. Cables not supplied by CLiC-iT.

> Utiliser des serres-câbles adaptés au choix du diamètre de câble (Ø10 ou Ø12) en acier forgé et marquage CE. Use cable clamps suitable for the forged steel cable diameter (Ø10 or Ø12) and CE marking you chose.

> Le système C-UP est conçu pour n'être utilisé que par une seule personne à la fois. The system is designed to be used by only one person at a time

> Utiliser uniquement les composants & pièces détachées fournis par la SARL DEHONDT. Use only components & spare parts supplied by SARL DEHONDT

> L'utilisation du C-UP sans C-ABS peut occasionner une force de choc importante et un risque de blessure pour l'utilisateur en cas de chute. Using the C-UP without C-ABS can cause extensive impact force and risk of injury for the user in the event of a fall

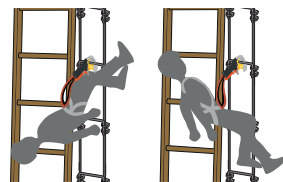

⚠ Pour éviter à l'utilisateur de se retrouver la tête vers le bas en cas de chute, il est recommandé de porter un harnais intégral.

⚠ To prevent the user ending up upside down in case of fall, it is recommended to wear a full body harness.

Contrôle visuel de l'absorbeur d'énergie (C-ABS) :

Visual control of the shock absorber (C_ABS) :

- Contrôler que l'absorbeur ne se soit pas déployé. Si l'indicateur de chute est visible, remplacer l'absorbeur. Check if the shock absorber has been opened. If the falling sign is visible, replace the shock absorber.



- Contrôler l'absence de déchirure ou moisissure sur les parties textiles et la gaine. Check if there is any tear or mold on textile parts or on the lanyard.

- Le C-ABS est à remplacer tous les ans. C-ABS must be changed every year.

Défauts de montage des C-UP :

C-UP incorrect assembling :

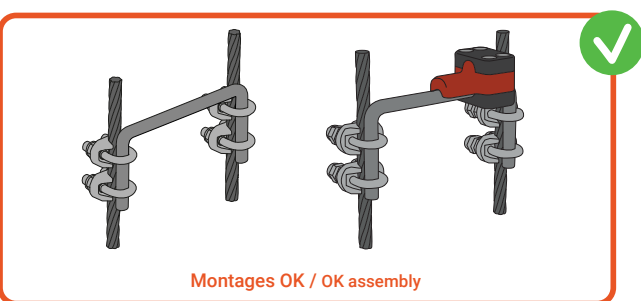
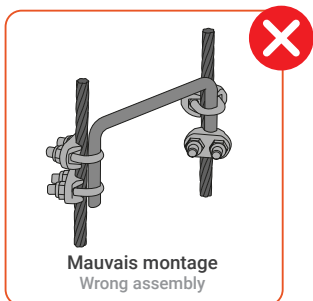
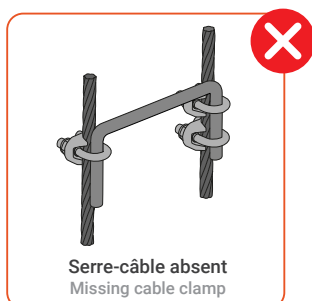
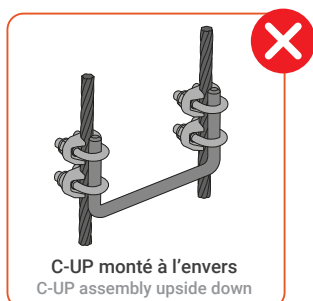

Utilisation des C-UP avec les connecteurs CLiC-iT :

C-UP use with CLiC-iT connectors :

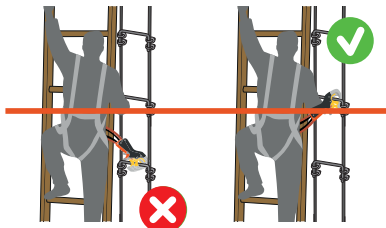
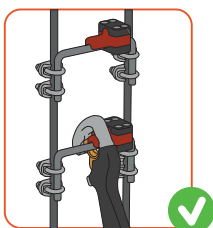
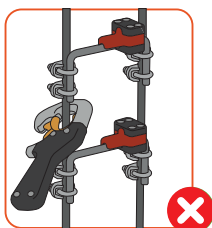

STORAGE RACK FOR LANYARDS CLiC-iT

Vertical storage of CLiC-iT : preserves control cables. Up to 80 CLiC-iT + harnesses.
Integrated control station. Good maneuverability with 4 directional wheels and brakes. Made of 2mm thick corrosion-resistant steel.

Dimensions with inflated wheels : 111*60*185cm
Dimensions : 111*60*177cm
Weight : 30kg

- Control procedure
- Cable to control your lanyards
- C-ZAM ring to go out of control station



Inflatable wheels option

Assembly



1. Separate the two parts



2. Assemble the two parts



3. Storage your lanyards

Use



1. For storing lanyards, connect on C-ZAM ring



2. When the C-RACK is static, lock the wheels with brakes



3. When checking the lanyards, take the «Text» sheet



4. Do not use if not unfolded



5. Attention: Risk of tilting



C8+



C-TWO



C-HOLDER

